

DE EASYTAB BEDIENPANEL

EN EASYTAB CONTROL PANEL

- 1 Turn off camera
- 2 Flash light
- 3 Camera settings
- 4 Settings brightness
- 5 Settings focus
- 6 Locating transmitter on/ off
- 7 Laser measurement



KUMMERT

Kummert GmbH
Albert-Einstein-Str. 8
D - 97447 Gerolzhofen

Tel. +49 (0) 9382 9727 - 0
info@kummert.de
www.kummert.de

DE CAN3D® BEDIENPANEL

- 1 Kamera abmelden
- 2 Kamera ausrichten
- 3 Lasermessung/ Schwenk auf 90°
- 4 Bild automatisch zentrieren/ 360° Drehung
- 5 Blitzlicht
- 6 Kontinuierliche Verlaufsmessung
- 7 Ortungssender
- 8 Kamera Einstellungen
- 9 Modus

Pfeil: Schieben
Auge: Feststellung
Pfeile: Frei drehen

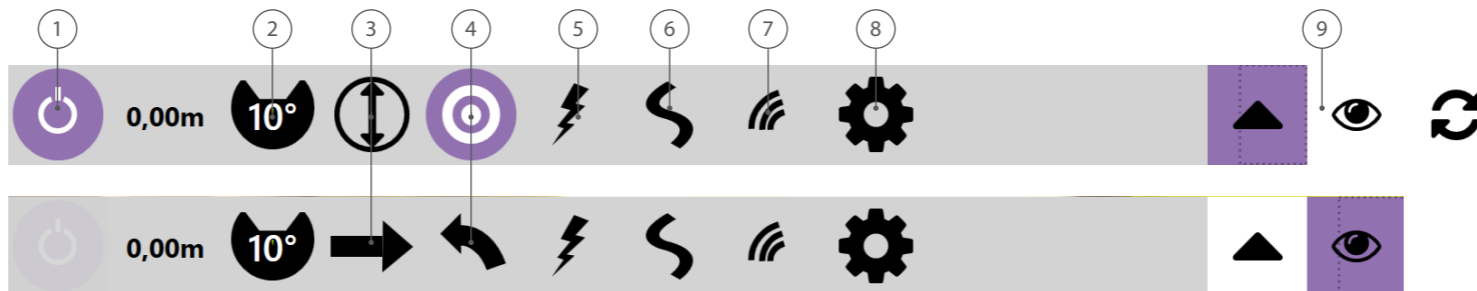

EN CAN3D® CONTROL PANEL

- 1 Turn off camera
- 2 Align
- 3 Laser measurement/ Pan to 90°
- 4 Center image automatically/ 360° rotation
- 5 Flash light
- 6 Continous measurement of pipe run
- 7 Locating transmitter on/ off
- 8 Camera settings
- 9 Modus

Arrow: Push mode
Eye: Finding mode
Arrows: Turning mode

K - 7 0 HD

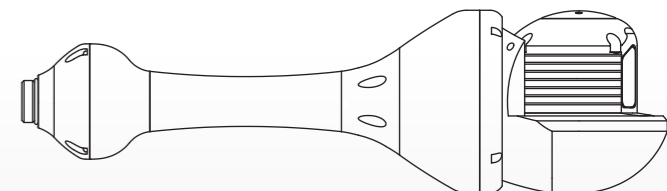

KURZANLEITUNG
K-70 HD

DE

QUICK START GUIDE
K-70 HD

EN

DE MONTAGE

EN MOUNTING

DE PROTAB

EN PROTAB

DE HELBIGKEIT REGELN

EN ADJUST BRIGHTNESS

DE FOKUS REGELN

EN ADJUST FOCUS

Entfernen Sie ggf. die Schutzkappe. Verbinden Sie die Kamerabuchse mit dem 4-poligen Stecker der Haspel. Achten Sie auf die korrekte Position der Kontakte.

Remove the protective cap from the connector. Connect the connector and the plug of the reel. Make sure that the pins are in the correct position.

DE:

- 1. 3D-Joystick
- 2. Drehknopf links/ rechts

EN:

- 1. 3D-joystick
- 2. Knob left/ right

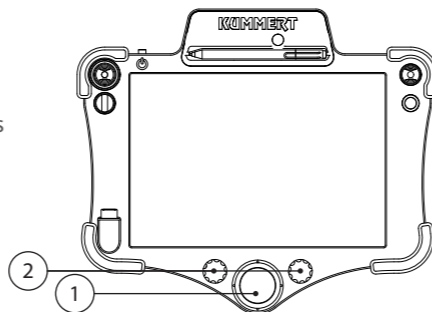

PROTAB

DE: Drehen Sie den rechten Drehknopf nach links oder rechts.

EN: Turn the right knob to the left or right.

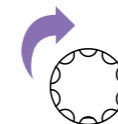

DE MODUS WECHSELN

EN SWITCH MODES

PROTAB

DE: Drücken Sie mittig auf den 3D-Joystick.

EN: Push the center of the 3D joystick.

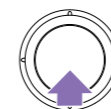

DE DREHEN UND SCHWENKEN

EN PAN AND TILT

PROTAB/ EASYTAB

DE: Bewegen Sie den 3D-Joystick.

EN: Move the 3D-joystick.

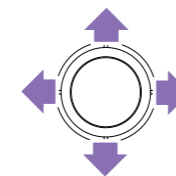

PROTAB/ EASYTAB

DE: Drehen Sie den 3D-Joystick nach links oder rechts.

EN: Turn the 3D joystick to the left or right.

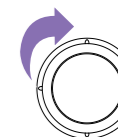

DE ZOOM (FESTSTELLUNGSMODUS)

EN ZOOM (FINDING MODE)

PROTAB

DE: Drehen Sie den linken Drehknopf nach links oder rechts.

EN: Turn the left knob to the left or right.

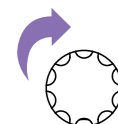

DE EASYTAB

EN EASYTAB

DE:

- 1. 3D-Joystick

EN:

- 1. 3D-joystick

